

SG 4910

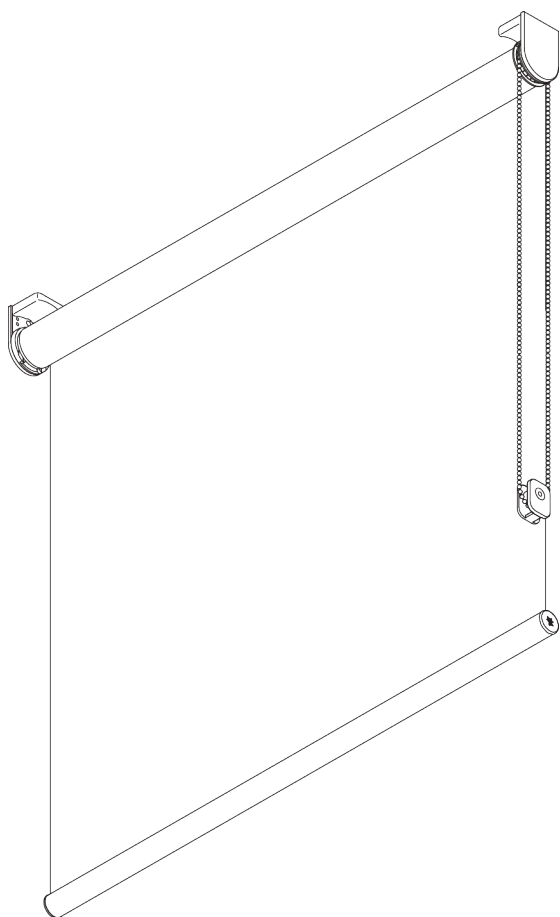
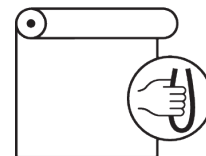

INFORMATION PRODUIT

- **Mode de commande :** Chaînette
- **Gamme:** S - M
- **Installation:** Plafond, Murale, Encastré
- **Couleurs:** Blanc RAL 9016, Gris RAL 7035, Noir RAL 9005; couleurs spéciales possibles
- **Tissus:** Se référer à la collection tissu Silent Gliss

Caractéristiques:

- Ressort de compensation, Manoeuvre sans effort
- Entraînement 1/1
- Chaînette acier inoxydable
- Support click, Fascia, boîtier, profil de montage
- Blocage de fin de course

03/2026/V1

SPÉCIFICATION SYSTÈME

A. DIMENSIONS SYSTÈME

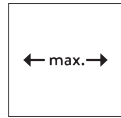

2.4 m

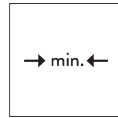

25 cm*,
Fascia / Boîtier: 60 cm
*25 - 60 cm uniquement
avec profil de montage
SG 10534

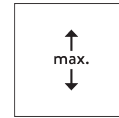

3 m



7.2 m²



3 kg

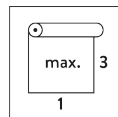

Rapport largeur / hauteur
recommandé
max. 1:3

Hauteur max. du système

Fixation murale (hauteur côté fenêtre)

Epaisseur tissu	mm	0.15	0.20	0.25	0.30	0.35	0.40	0.45	0.50	0.55	0.60	0.65	0.70	0.75	0.80
Hauteur maxi du système	cm	300	300	300	300	300	300	300	300	300	290	270	250	230	220

Fixation plafond (hauteur côté pièce)

Epaisseur tissu	mm	0.15	0.20	0.25	0.30	0.35	0.40	0.45	0.50	0.55	0.60	0.65	0.70	0.75	0.80
Hauteur maxi du système	cm	300	300	300	300	300	300	300	300	300	300	300	300	300	280

B. PROFIL

Information profil

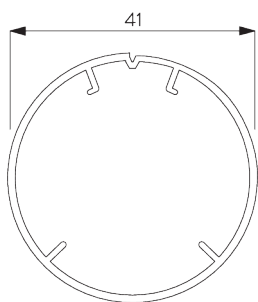

SG 10531
Profil ø 41 mm

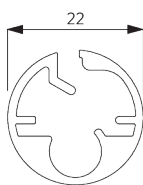

SG 10760
Barre de lestage

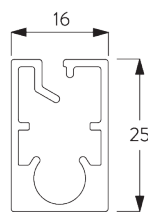

SG 10770
Barre de lestage



SG 4903
Barre de lestage

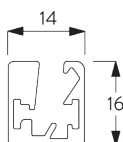

SG 11442
Barre de lestage

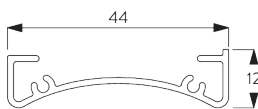

SG 10534
Profil de montage

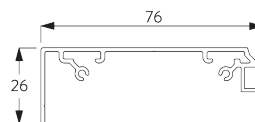

SG 11430
Profil de montage 73 mm

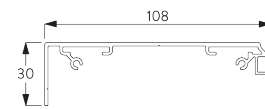

SG 11530
Profil de montage 110 mm

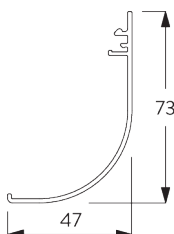

SG 11431
Fascia rond 73 mm

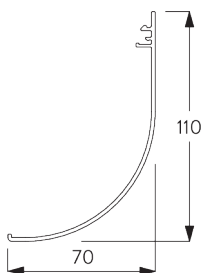

SG 11531
Fascia rond 110 mm

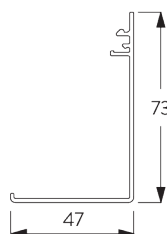

SG 11432
Fascia carré 73 mm

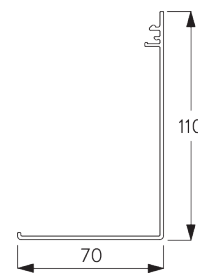

SG 11532
Fascia carré 110 mm

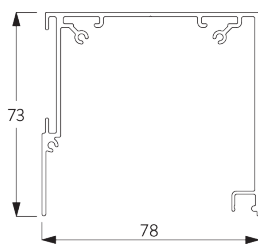

SG 11433
Boîtier 73 mm

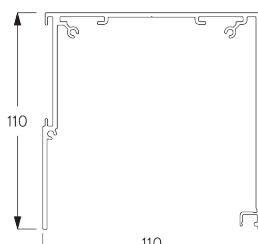

SG 11533
Boîtier 110 mm

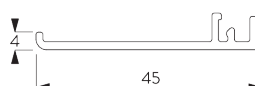

SG 11434
Boîtier cache

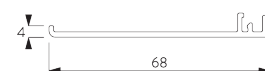

SG 11534
Boîtier cache 110 mm

C. PRISE DE MESURE

y compris cache support

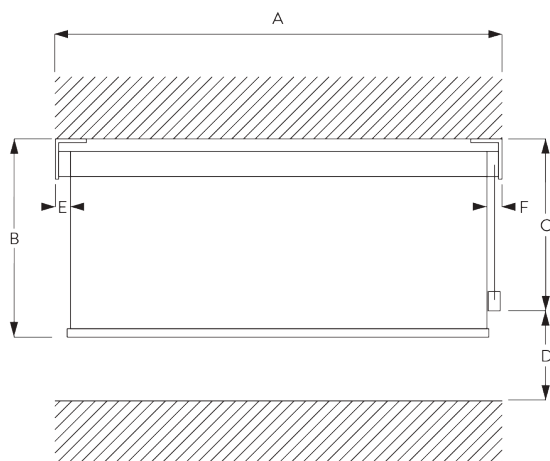

A: Largeur du système
B: Hauteur du système
C: Hauteur chaînette
D: Sécurité SG 10731 min. 150 cm du sol
E: Passage lumière: 13 mm
F: Passage lumière côté manoeuvre: 18 mm

Note:
Toutes les dimensions comprennent 2 mm pour les cache support par côté!

Fascia / Boîtier

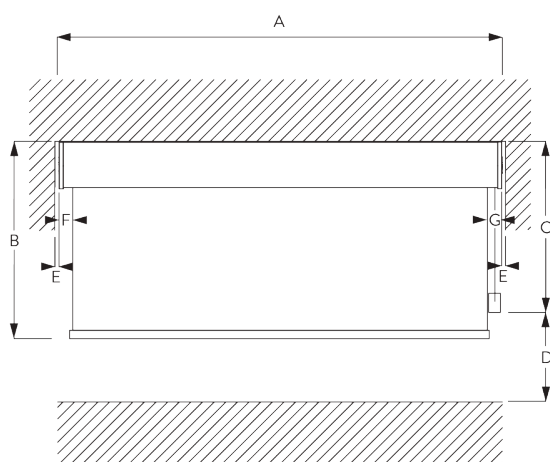

A: Largeur du système
B: Hauteur du système
C: Hauteur chaînette
D: Sécurité SG 10731 min. 150 cm du sol
E: Écart: min. 10 mm (lorsque le cache support est utilisé)
F: Passage lumière: 15 mm
G: Passage lumière côté manoeuvre: 21 mm

INSTALLATION

A. INSTRUCTION DE POSE

Pour des informations détaillées, se référer au site web Silent Gliss.

Points de fixation



Supports (mural / plafond)

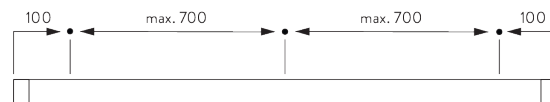

Fascia / boîtier & profil de montage SG 10534 (mural / plafond)

B. FIXATION
PLAFOND

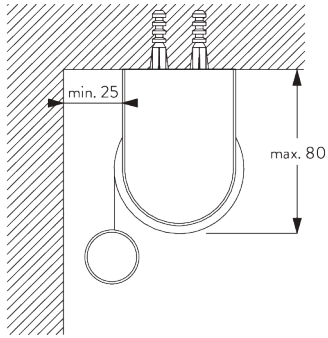

Supports

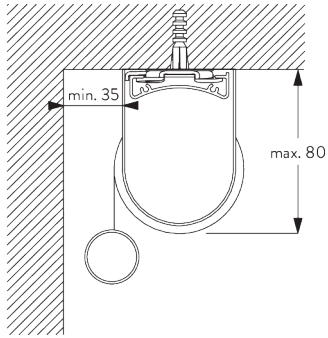

Profil de montage SG 10534 et bride SG 3033 ou SG 3044

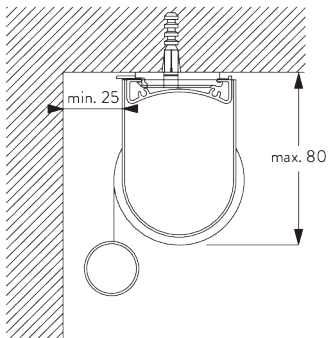

Profil de montage SG 10534 et support click SG 10539

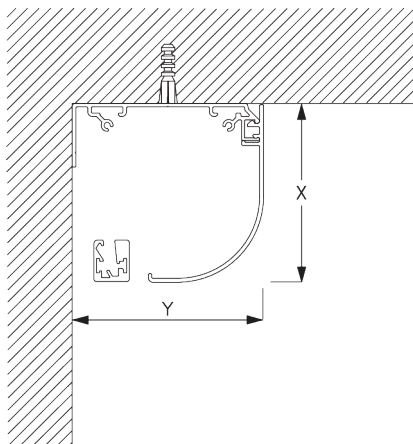

Fascia rond

X = Fascia S 73 mm / Fascia L 110 mm

Y = Fascia S 78 mm / Fascia L 110 mm

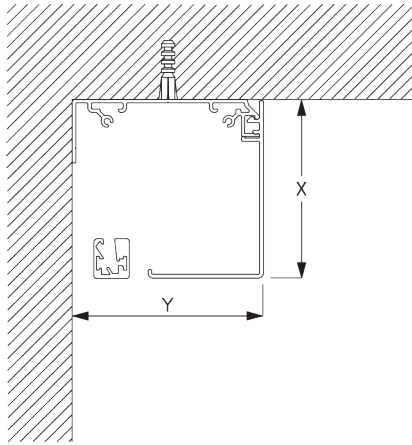

Fascia carré

X = Fascia S 73 mm / Fascia L 110 mm

Y = Fascia S 78 mm / Fascia L 110 mm

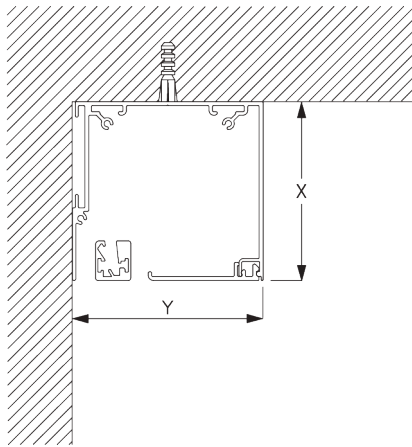

Boîtier

X = Boîtier S 73 mm / Boîtier L 110 mm

Y = Boîtier S 78 mm / Boîtier L 110 mm

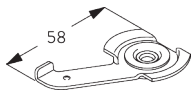

SG 3033

Bride

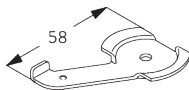

SG 3044

Bride

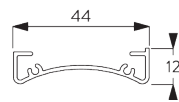

SG 10534

Profil de montage

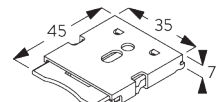

SG 10539

Support click

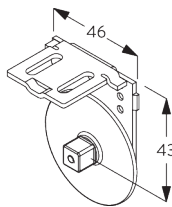

SG 10542

Support côté commande

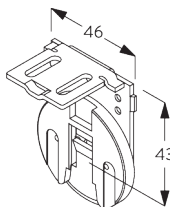

SG 10543

Support



SG 10574

Cache support

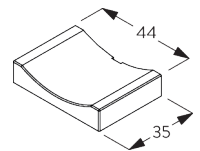

SG 10575

Cache pour vis

C. FIXATION
MURALE

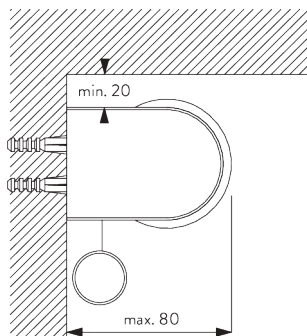

Supports

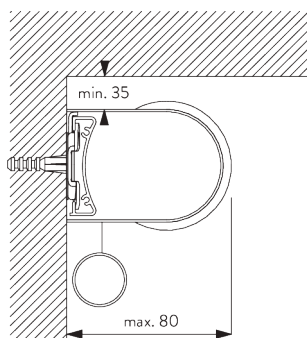

Profil de montage SG 10534 et bride SG 3033 ou SG 3044

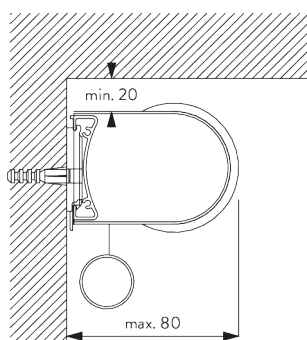

Profil de montage SG 10534 et support click SG 10539

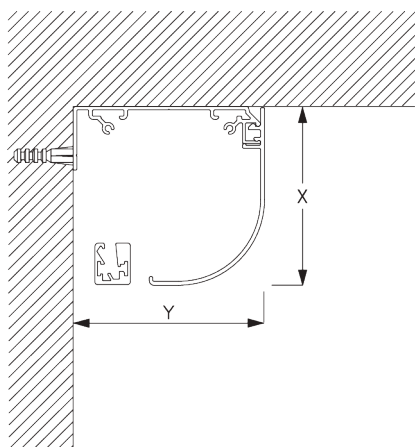

Fascia rond

X = Fascia S 73 mm / Fascia L 110 mm

Y = Fascia S 78 mm / Fascia L 110 mm

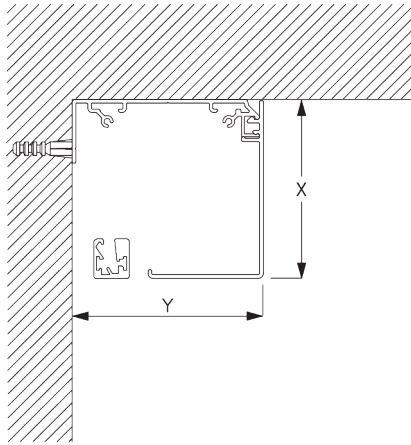

Fascia carré

X = Fascia S 73 mm / Fascia L 110 mm

Y = Fascia S 78 mm / Fascia L 110 mm

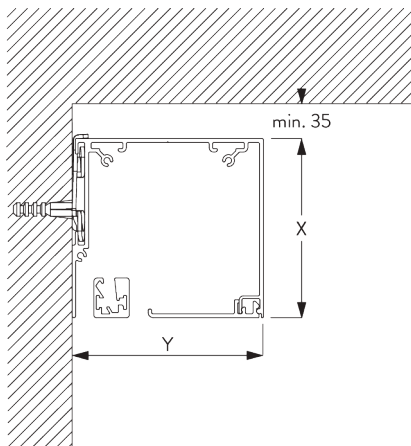

Boîtier S avec bride SG 3044 / Boîtier L avec bride SG 11180

X = Boîtier S 73 mm / Boîtier L 110 mm

Y = Boîtier S 78 mm / Boîtier L 110 mm

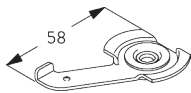

SG 3033

Bride

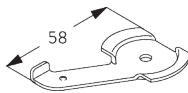

SG 3044

Bride

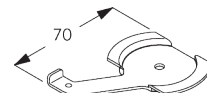

SG 11180

Bride

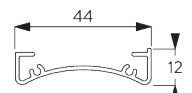

SG 10534

Profil de montage

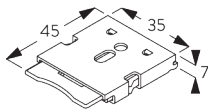

SG 10539

Support click

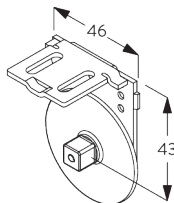

SG 10542

Support côté commande

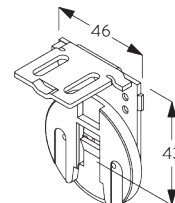

SG 10543

Support

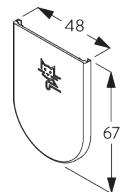

SG 10574

Cache support

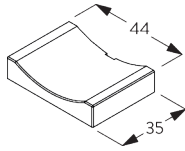

SG 10575

Cache pour vis

**D. FIXATION
ENCASTRÉE**

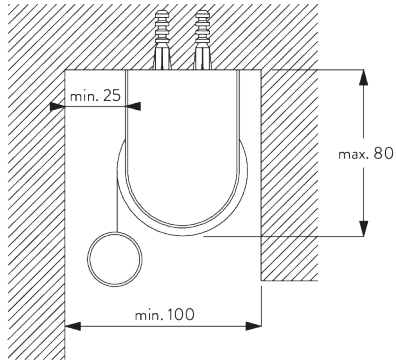

Supports

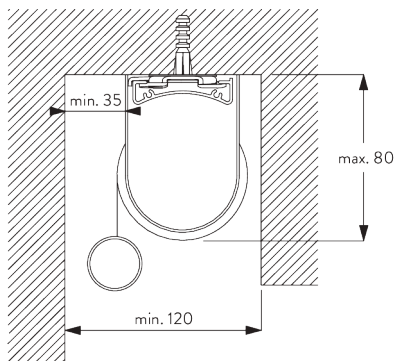

Profil de montage SG 10534 et bride SG 3033 ou SG 3044

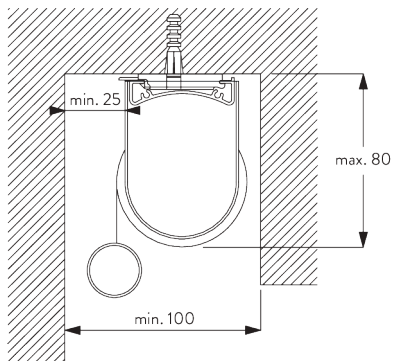

Profil de montage SG 10534 et support click SG 10539

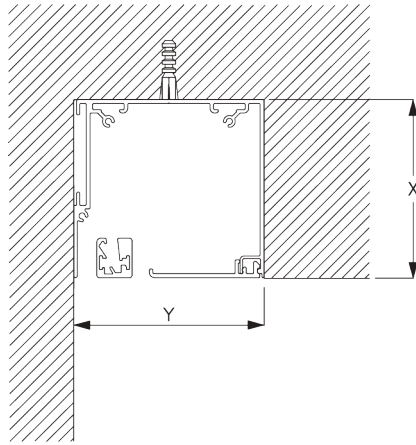

Boîtier

X = Boîtier S 73 mm / Boîtier L 110 mm

Y = Boîtier S min. 79 mm / Boîtier L min. 111 mm

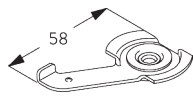

SG 3033

Bride

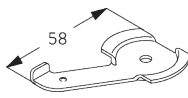

SG 3044

Bride

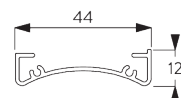

SG 10534

Profil de montage

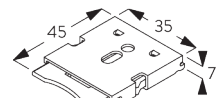

SG 10539

Support click

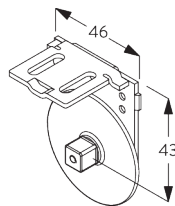

SG 10542

Support côté commande

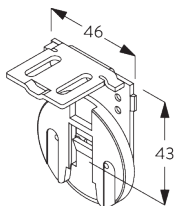

SG 10543

Support



SG 10574

Cache support

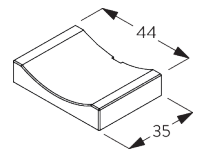

SG 10575

Cache pour vis

**E. FIXATION AVEC
OPTION DE
GUIDAGE**

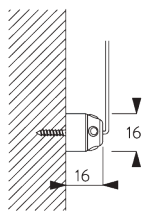
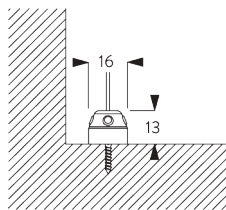

Systeme simple

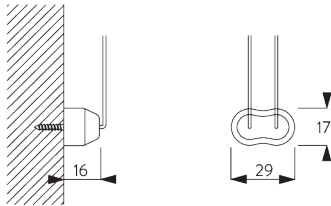
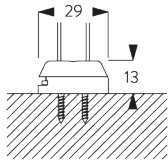

Système double (installation juxtaposée)

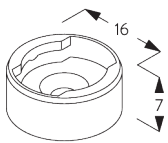

SG 8235
Base basse

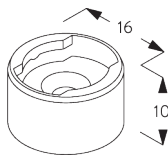

SG 8236
Base basse longue

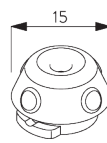

SG 8237
Serre câble

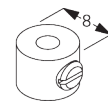

SG 8249
Serre câble

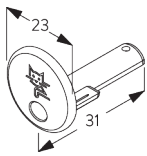

SG 10762
Embout pour barre de lestage
(guidage)

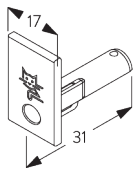

SG 10772
Embout pour barre de lestage
(guidage)

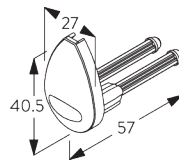

SG 4944
Embout pour barre de lestage
(guidage)

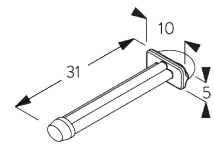

SG 10641
Oeillet de guidage pour
embout barre de lestage

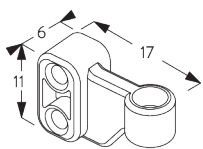

SG 10642
Support de guidage câble

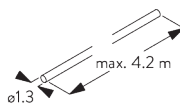

SG 10643
Câble ø 1.3 mm x 4.2 m
(guidage)

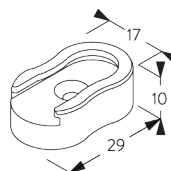

SG 10669
Base longue pour guidage
double système

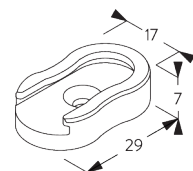

SG 10673
Base courte pour guidage
double système

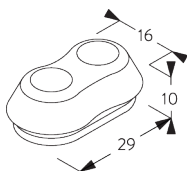

SG 10701
Support pour guidage double
système

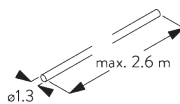

SG 10706
Câble ø 1.3 mm x 2.6 m
(guidage)

OPTIONS SYSTÈME

A. DÉROULEMENT DE LA TOILE

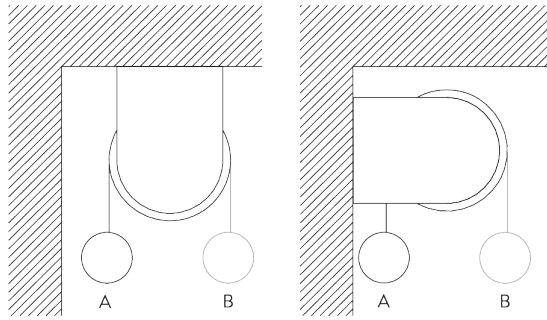

A: Déroulement au plus près de la fenêtre (standard)
B: Déroulement vers l'intérieur de la pièce (option)

B. PROFIL DE MONTAGE

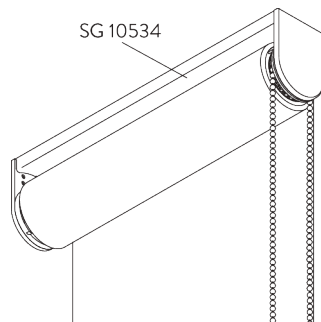

C. ARRÊT DE FIN DE COURSE AJUSTABLE

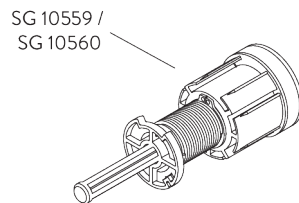

Programmation fin de course haute et basse.

D. GUIDAGE

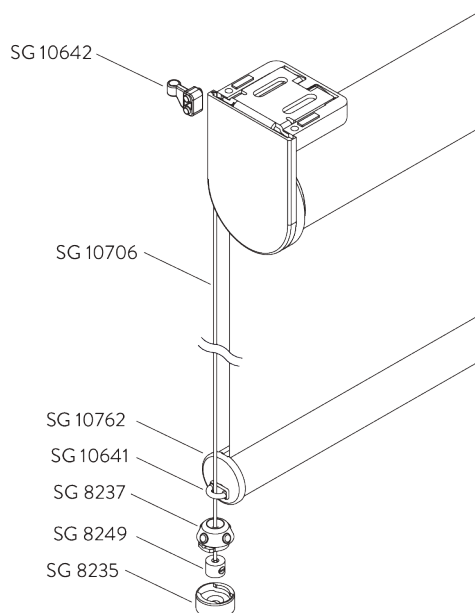

Accessoires complémentaires:

- 2x SG 8235 Base de fixation du câble
- 2x SG 8237 Serre câble
- 2x SG 8249 Serre câble
- 2x SG 10762 Embout pour barre de lestage ronde guidage
- 2x SG 10641 Oeillet de guidage embout pour barre de lestage
- 2x SG 10642 Pièce d'accroche câble haute
- 2x SG 10706 Câble de guidage \varnothing 1.3 mm x 2.6 m

Accessoires optionnels:

- 2x SG 8236 Base basse longue de fixation du câble
- 2x SG 10772 Embout rectangle de barre de charge
- 2x SG 10643 Câble \varnothing 1.3 mm x 4.2 m
- 2x SG 10669 Base longue de fixation du câble
- 2x SG 10673 Base courte de fixation du câble
- 2x SG 10701 Support double de fixation du câble

Note:

- Le passage de lumière latéral augmente avec l'option de guidage
- Guidage sur pente maxi de 15°

E. DEUX SYSTÈMES CÔTE À CÔTE

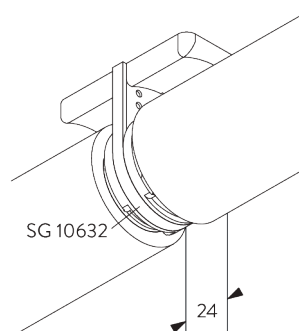

Accessoire complémentaire:

- 1x SG 10632 Cache pour 2 supports ensemble

F. SÉCURITÉ ENFANT

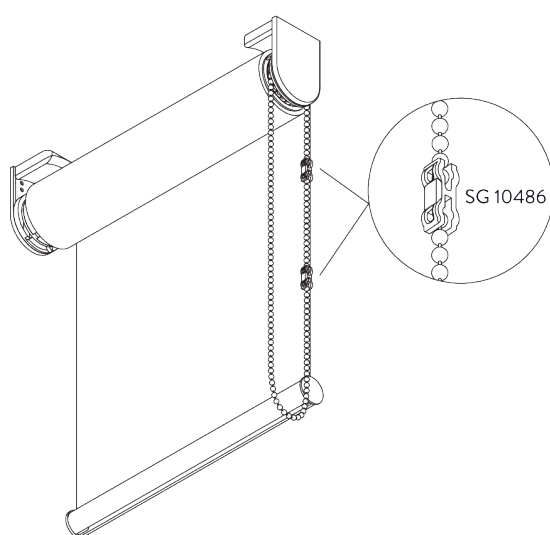

Le connecteur sécurisé pour enfants SG 10486 libère la chaîne quand la force de traction dépasse 6 kg.

Note:

- Système à installer pour une boucle de chaîne du dispositif de sécurité enfants au moins à 60 cm du sol.

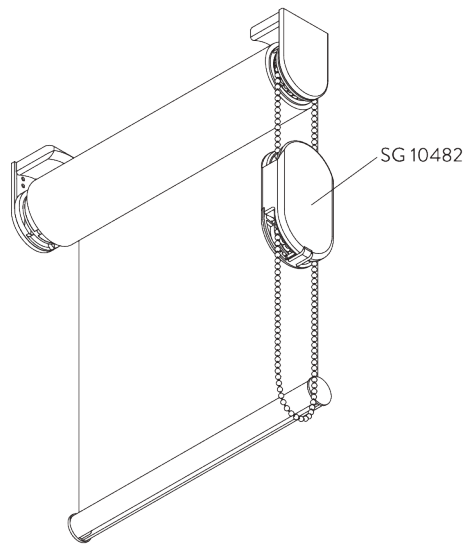

Le dispositif de sécurité pour enfants SG 10482 libère la chaîne quand la force de traction dépasse 6 kg.

Note:

- Système à installer pour une boucle de chaîne du dispositif de sécurité enfants au moins à 60 cm du sol.

G. FASCIA / BOÎTIER



A: Fascia rond

B: Fascia carré

C: Boîtier

Tailles:

- S: 78 x 73 mm

- L: 110 x 110 mm

Note:

- Utilisable uniquement avec la barre de lestage SG 11442

ACCESSOIRES

A. ACCESSOIRES STANDARDS

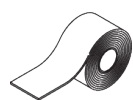

SG 4226

Bande adhésif 30 mm



SG 10530

Chaînette métallique ø 4 mm



SG 10531

Profil ø 41 mm

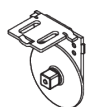

SG 10542

Support côté commande

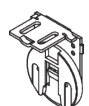

SG 10543

Support

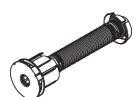

SG 10547

Set ressort C Gauche - 641mm

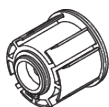

SG 10556

Adaptateur pour profil



SG 10574

Cache support

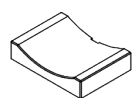

SG 10575

Cache pour vis

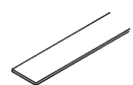

SG 10668

Bande adhésif 10 mm



SG 10731

Poulie de sécurité pour chaînette & cordon



SG 10760

Barre de lestage



SG 10761

Embout pour barre de lestage

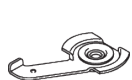

SG 3033

Bride



SG 3044

Bride



SG 4903

Barre de lestage



SG 8235

Base basse

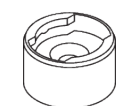

SG 8236

Base basse longue



SG 8237

Serre câble

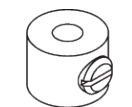

SG 8249

Serre câble

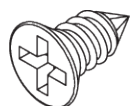

SG 10139

Vis 2.9x6.5

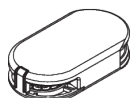

SG 10482

Kit sécurité enfant, chaînette métallique ø 4.0 mm

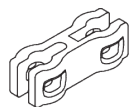

SG 10486

Connecteur/Arrêt chaînette

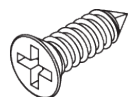

SG 10498

Vis 2.9x9.5

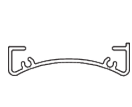

SG 10534

Profil de montage

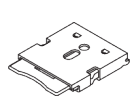

SG 10539

Support click



SG 10545

Set ressort A Gauche - 420mm



SG 10546

Set ressort B Gauche - 487mm

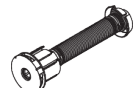

SG 10548

Set ressort D Gauche - 721mm



SG 10549

Set ressort E Gauche - 824mm

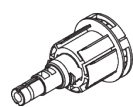

SG 10550

Embout entrainement chaînette (40mm)



SG 10551

Set ressort A Droite - 420mm

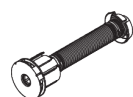

SG 10552

Set ressort B Droite - 487mm

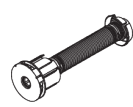

SG 10553

Set ressort C Droite - 641mm



SG 10554

Set ressort D Droite - 721mm

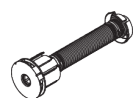

SG 10555

Set ressort E Droite - 824mm

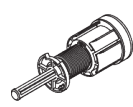

SG 10559

Fin de course gauche

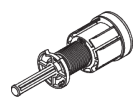

SG 10560

Fin de course droite



SG 10632

Cache pour 2 supports

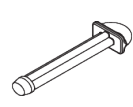











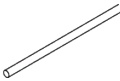







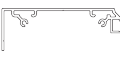
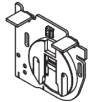

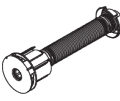
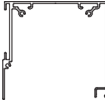
SG 10641

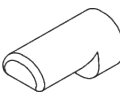
Oeillet de guidage pour embout barre de lestage

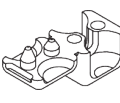

SG 10642

Support de guidage câble

	SG 10643 Câble ø 1.3 mm x 4.2 m (guidage)		SG 10771 Embout pour barre de lestage		SG 11443 Embout de barre de charge
	SG 10669 Base longue pour guidage double système		SG 10772 Embout pour barre de lestage (guidage)		SG 11446 Support gauche 73 mm
	SG 10673 Base courte pour guidage double système		SG 11178 Embout pour barre de lestage		SG 11447 Support droite 73 mm
	SG 10690 Cale		SG 11180 Bride		SG 11448 Support gauche 73 mm
	SG 10697 Set ressort F Gauche - 921mm		SG 11430 Profil de montage 73 mm		SG 11449 Support droite 73 mm
	SG 10698 Set ressort G Gauche - 921mm		SG 11431 Fascia rond 73 mm		SG 11530 Profil de montage 110 mm
	SG 10699 Set ressort F Droite - 921mm		SG 11432 Fascia carré 73 mm		SG 11531 Fascia rond 110 mm
	SG 10700 Set ressort G Droite - 921mm		SG 11433 Boîtier 73 mm		SG 11532 Fascia carré 110 mm
	SG 10701 Support pour guidage double système		SG 11434 Boîtier cache		SG 11533 Boîtier 110 mm
	SG 10706 Câble ø 1.3 mm x 2.6 m (guidage)		SG 11437 Cache support rond gauche 73 mm		SG 11534 Boîtier cache 110 mm
	SG 10707 Arrêt pour barre de lestage		SG 11438 Cache support rond droit 73 mm		SG 11537 Cache support rond gauche 110 mm
	SG 10709 Arrêt de fin de course		SG 11439 Cache support carré gauche 73 mm		SG 11538 Cache support rond droit 110 mm
	SG 10762 Embout pour barre de lestage (guidage)		SG 11440 Cache support carré droit 73 mm		SG 11539 Cache support carré gauche 110 mm
	SG 10770 Barre de lestage		SG 11442 Barre de lestage		SG 11540 Cache support carré droit 110 mm

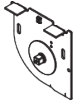

SG 11546

Support gauche 110 mm



SG 11547

Support droite 110 mm



SG 11548

Support gauche 110 mm



SG 11549

Support droite 110 mm
